

Quick Setup Guide for VARA FM 3.0.5 and higher for Winlink with Signalink on Windows

By Oliver K6OLI

Last Update v2020-03-09

Special thanks go to **Scott KI6SC**, **Martin HB9AUR**, **Keith KD6PYD**, **Brian KM6IGY**, **Jeff W2JCL**, **Tom KN6BKT**, **Mike KM6KAQ**, **Jim KM6TGJ (SK)**, **Ken KI7EIH** and **Scott NS7C** for your testing, for your suggestions, insights and encouragement.

Get the Software

Download

- VARA FM: download VARA FM directly from here <https://rosmodem.wordpress.com/>, or follow the link for VARA FM in Winlink Express, then extract the install files in a location you can find easily (e.g. Desktop). Now double-click the install file and install it in C:\VARA FM\
- VARA FM is a separate program from VARA Modem. If you want to only use VARA FM, only download VARA FM. If you want to use VARA on HF you should also download and install VARA Modem.
- NOTE: Some antivirus programs may identify VARAFM.exe as a Trojan or virus. It is a false positive. Create an exception in your antivirus program for the folder VARAFM.exe is located in.
- NOTE: VARA FM can cause Signalink sputtering when third-party antivirus programs are present. Removing the third party antivirus and using Windows Defender is one solution.
- NOTE: VARA FM works perfectly fine without a license key. The key only unlocks the higher speeds. Basic VARA FM will be more than twice as fast as Packet.
- NOTE: VARA FM 3.0.5 and higher are not compatible with VARA FM 1.3.0 or lower. We recommend upgrading to VARA FM 3.0.5 or higher.

Soundcard Considerations

After you have hooked up your Signalink please make sure it is not selected as the default audio device.

Right Click on the Windows Icon



Select **Run**

Type or copy and paste **control mmsys.cpl**

Press **Enter**

Select **Playback**

Right click on your computer soundcard

Select **Set Default Device**

Right click on your computer soundcard

Select **Set As Default Communication Device**

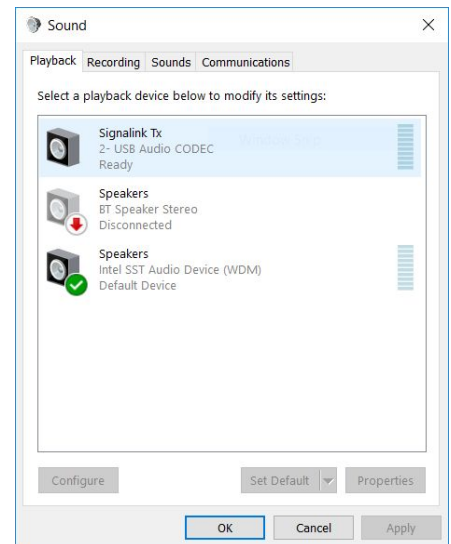

Then select **Recording**. Right-click your computer's internal soundcard and **Set as Default Device** and then right-click again and **Set as Default Communication Device**. There should be a green check mark on the internal soundcard device now.

Then click **OK**.

Quick Tip: Soundcard Shortcut

- Right-click on **Desktop**
- Select **Create Shortcut**
- In "Type the location of the item" copy and paste **control mmsys.cpl**
- Click **Next**
- Type **Soundcards**
- Click **Finish**

Customize your Soundcards Shortcut icon:

Properties -> Shortcut -> Change Icon -> paste **C:\Windows\system32\SHELL32.dll**

Also make sure that Signalink is not your active Playback Device. You can select your active playback device by left

clicking on the speaker icon  and selecting any playback device other than USB Audio CODEC. Selecting Speakers/Headphones in the example here is a good idea.

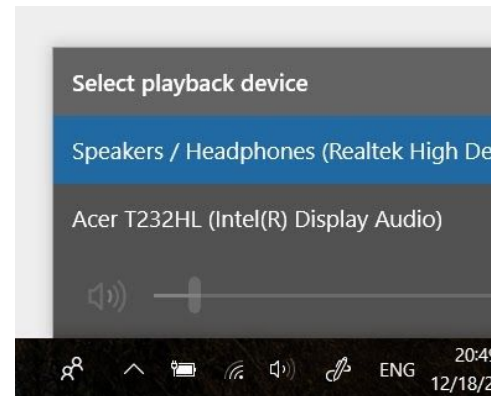

Signalink Settings

Set the TX and RX dials on your Signalink to the 9 o'clock position. You can adjust that later if needed. Set DLY(delay) to the 7:30 setting, halfway between the first and the second notches.

VU Meter:

Open the squelch on your transceiver or press the monitor button. Adjust the Signalink RX dial on your Signalink so that the VU meter needle is in the center or slightly left of center. You want to avoid the red zone.

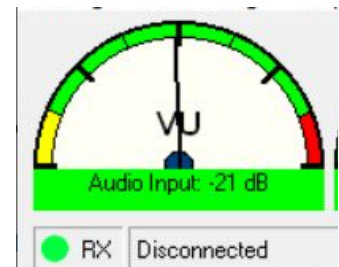

Signalink Audio Settings in Windows¹:

With Signalinks your Windows settings for USB Audio CODEC audio levels should be ... 100% for Speakers and ...

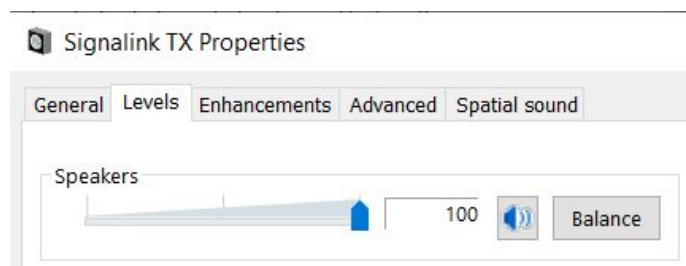

¹ Access the settings: **Right Click on the Windows Icon** ; Select **Run** ; Type or copy and paste **control mmsys.cpl** ; Press **Enter**

... as near to 0dB for Microphone as possible.

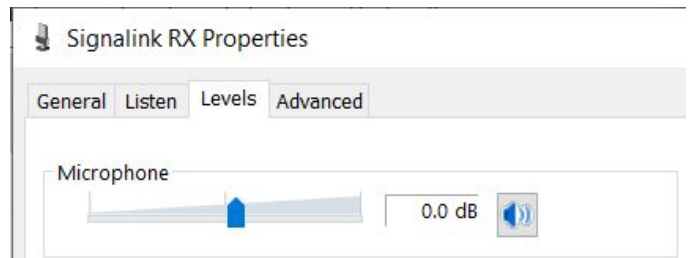

Setting up Winlink for VARA FM

Open Winlink Express

In the Open Session window select **VARA FM P2P²** or **VARA FM Winlink**

Click on **Open Session**

You will see this screen:

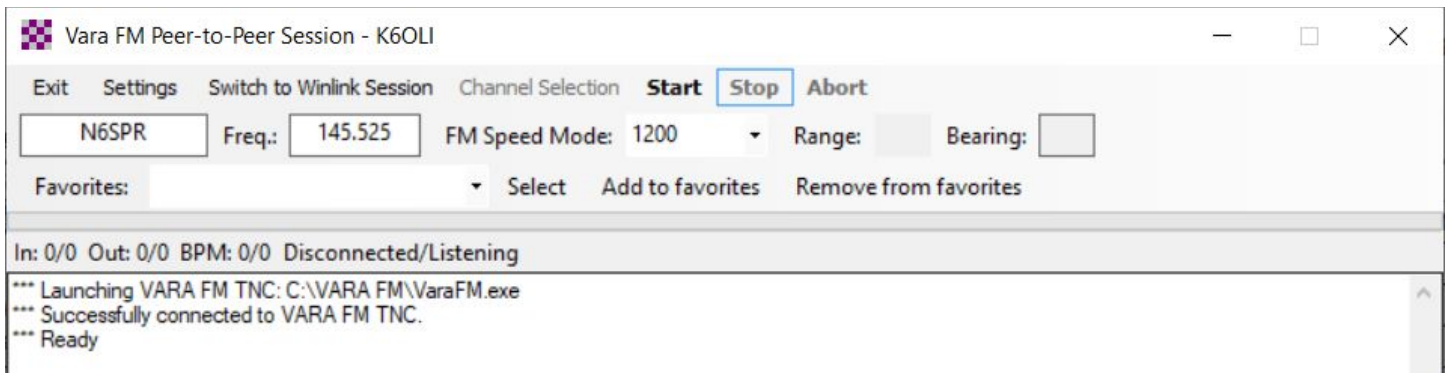

² VARA FM settings carry over from the VARA P2P to the Winlink VARA Session and vice versa

VARA FM Winlink TNC Setup

Click on **Settings**
Select **VARA TNC Setup**

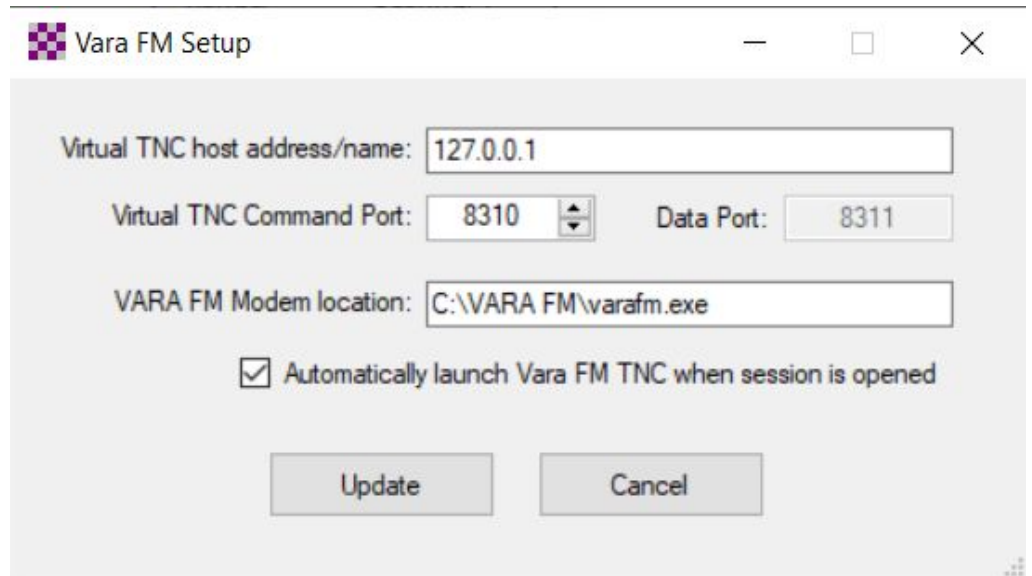

Virtual TNC host address/name: **127.0.0.1**

Virtual TNC Command Port: **8300³**

VARA Modem location **C:\VARA FM\VaraFM.exe** (or the path you chose during VARA FM install, if different from default).

Check Automatically Launch VRA FM TNC when session is opened, if you want that VARA FM launches automatically.

Click **Update**.

Quick Tip: NARROW vs WIDE

Pin 1200 is limited to 3kHz audio bandwidth. **Only VARA FM NARROW** can be used with pin 1200.

Pin 9600 is limited to 6kHz audio bandwidth. So either VARA FM NARROW or WIDE can be used.

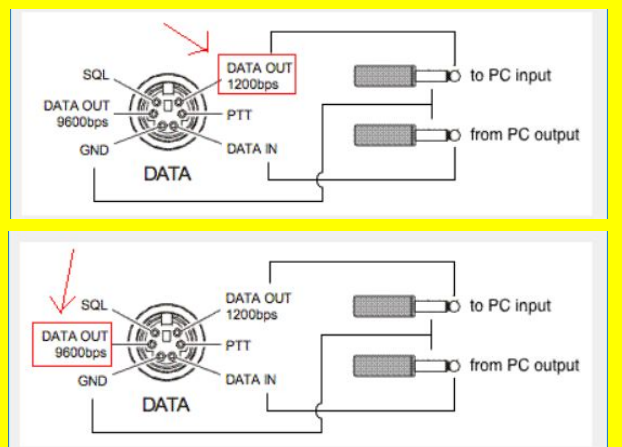

³ In the screenshot above it is set to 8310 due to personal preference.

You need a 9600 capable transceiver in order to use VARA FM WIDE or a transceiver with a built-in soundcard, like the IC-7100, for example.

The transformers in current Signalinks max out at 4000Hz, whereas VARA FM WIDE can reach 5800Hz bandwidth.

VARA FM Modem Setup

Click on the VARA FM Modem icon next to the Winlink Express icon at the bottom of your screen.

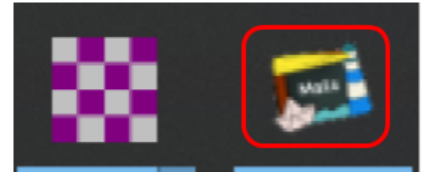

You will see this screen:

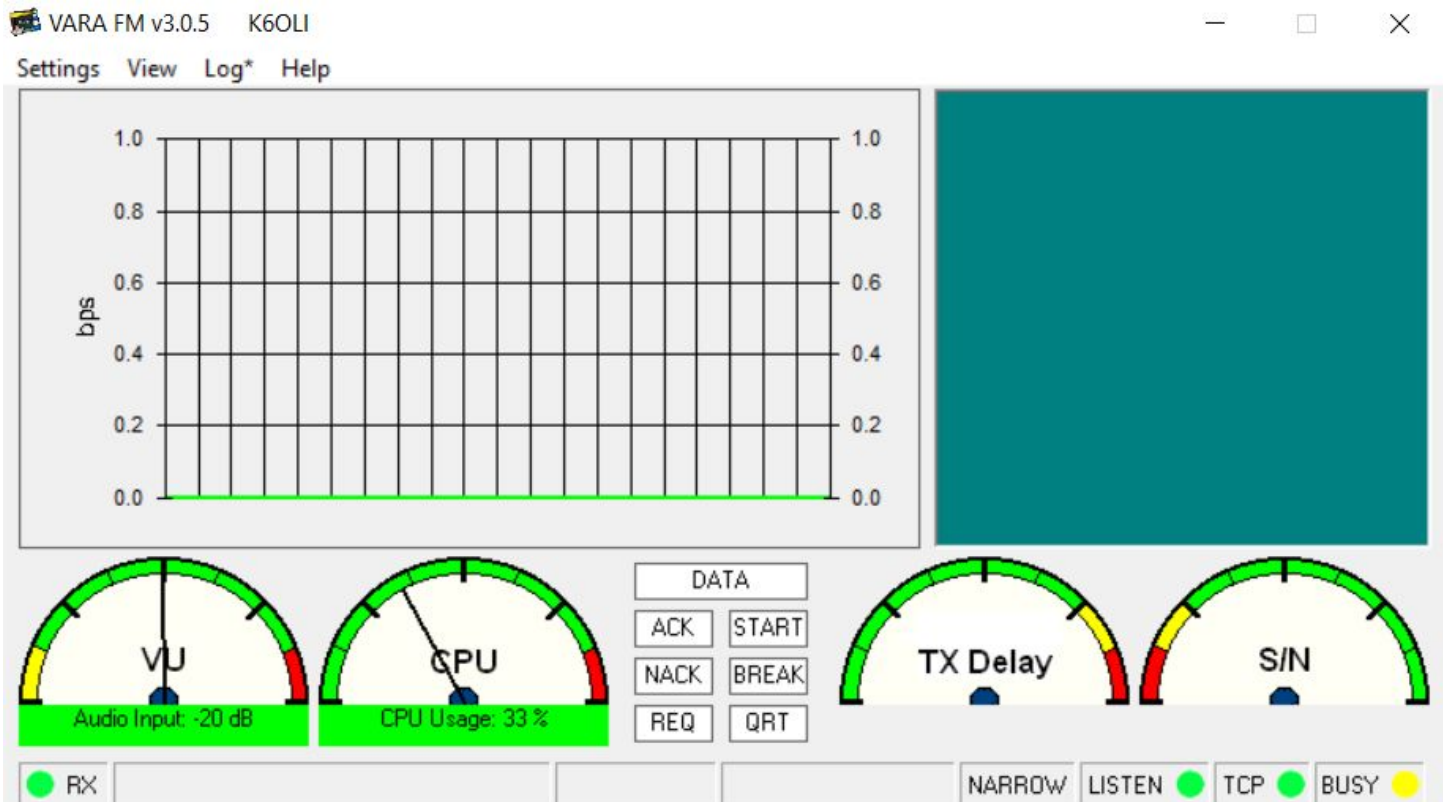

VARA FM Setup

Click on **Settings**
Select **VARA Setup**

Make sure the following is set

TCP Ports: Command **8300**⁴

FM System: **NARROW**

⁵Registration Key: (here is where you enter your registration key if you have one)

Retries: **2**

Click **Close**

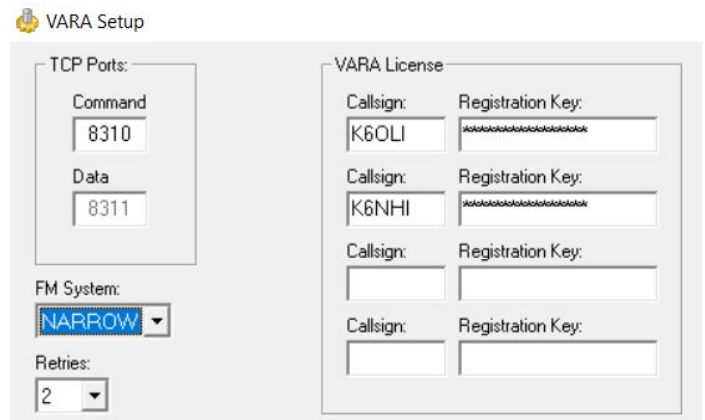

Special note: VARA FM 3.0.5 and higher set the software TX Delay automatically.

For best results with a Signalink we recommend setting the Signalink Delay (DLY) to the 7:30 setting, i.e. halfway between the first and the second notches. You will find that the VARA FM TX Delay will drop dramatically.

VARA FM SoundCard Setup

Click on **Settings**
Select **SoundCard**

Make sure the following is set

Device Input: **USB Audio CODEC**

Device Output: **USB Audio CODEC**

Drive Level: **-8dB**

Click **Close**

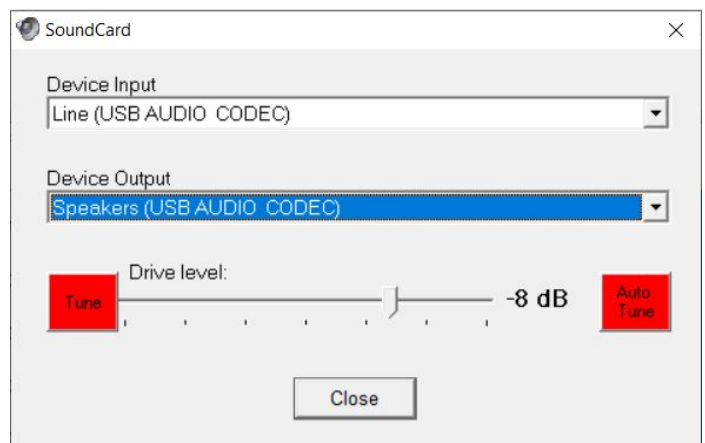

Note: This selects your Signalink as the Output and Input device for VARA FM and Winlink Express.

Note: The Signalink may sometimes show up as 2-USB Audio CODEC or similar.

⁴ I use port 8310. This must match the port you selected in Winlink VARA FM Session above.

⁵ Use NARROW for Signalinks and similar devices using a microphone or 1200 pin configuration. Use WIDE for RA-boards, X50, boards and similar devices using the 9600 pin configuration. NARROW and WIDE are cross compatible.

Auto Tune

Auto tune is a practical feature to optimize your signal.

You can autotune with a gateway or with a peer. When tuning with a peer make sure he/she is running VARA FM 3.0.5 or higher and VARA FM is running when you try to tune.

Ideally you tune with a station that has a good signal to you.

You only need to tune once for a specific radio, antenna, location, combination.

Click on **Auto Tune**

Enter the call sign of the station you want to tune with, in this example, K6YZF-11



Click on the power plug icon

VARA FM will key the radio and go through a number of levels. The other station will transmit results. VARA FM uses these results to either

- a) Set the drive level automatically
- b) Recommend setting changes on the Signalink

Click **Close**

PTT

Choose **Settings**

Select **PTT**

Set radio button to **VOX**

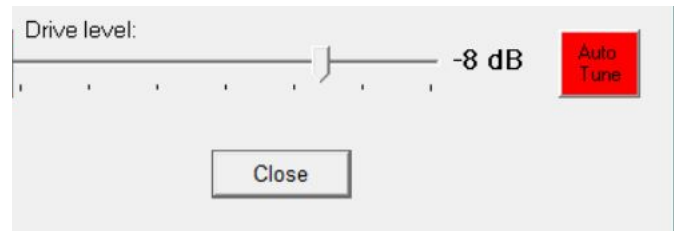

Done! You are now set up to use VARA FM. It is a good idea to exit your VARA FM P2P session at this point and re-initialize it to ensure the changes are saved.

Winlink Operation

Winlink VARA FM P2P Connection

Make sure both stations are in a VARA FM P2P session

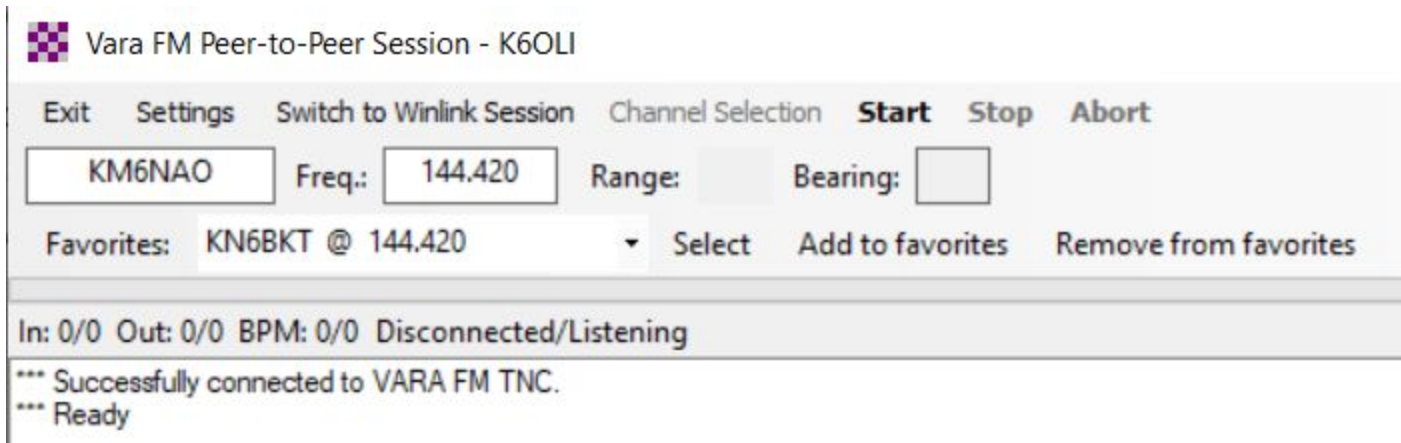

The screenshot shows the Winlink VARA FM Peer-to-Peer Session interface for station K6OLI. The window title is "Vara FM Peer-to-Peer Session - K6OLI". The interface includes a menu bar with "Exit", "Settings", "Switch to Winlink Session", "Channel Selection", "Start", "Stop", and "Abort". Below the menu bar, there are input fields for "KM6NAO", "Freq.: 144.420", "Range:", and "Bearing:". A "Favorites:" section shows "KN6BKT @ 144.420" with a dropdown arrow, and buttons for "Select", "Add to favorites", and "Remove from favorites". The status bar at the bottom displays "In: 0/0 Out: 0/0 BPM: 0/0 Disconnected/Listening" and two lines of status messages: "*** Successfully connected to VARA FM TNC." and "*** Ready".

Enter the call sign of the station you are trying to connect with.

Enter a frequency in the **Freq.:** field.

Note: For Signalinks the frequency itself is of no consequence, but it is best operating practice to enter the frequency you are working. It will matter once you use a rig with CAT.

Ensure that your transceiver is set to the correct frequency.

Click **Start**

VARA FM will connect and any Peer-to-peer traffic in your outbox addressed to the receiving station will be passed.

Signalinks do not support the full speed of VARA FM WIDE. VARA FM WIDE works with radios that allow access to the discriminator and an RA-board, rig built-in soundcard or homebrew USB soundcard interface. For more details see Appendix I below.

VARA FM NARROW uses the microphone path and is compatible with the greatest number of radios.

Check the Google Groups for suggestions on building a USB soundcard interface:

<https://groups.google.com/forum/#!forum/winlink-programs-group>

<https://groups.google.com/forum/#!forum/varahfmodem>

VARA FM Winlink Session

 Vara FM Winlink Session - K6OLI

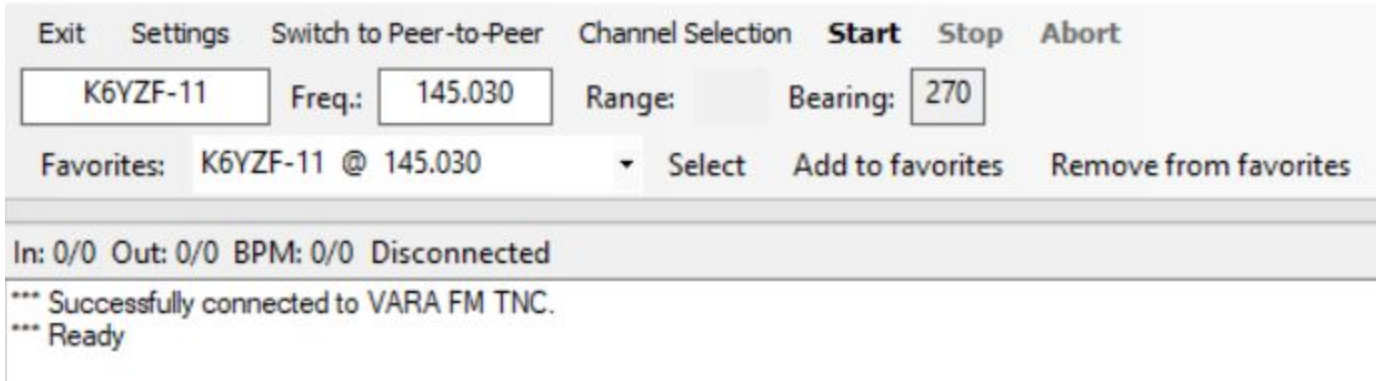

Exit Settings Switch to Peer-to-Peer Channel Selection **Start** Stop Abort

K6YZF-11 Freq.: 145.030 Range: Bearing: 270

Favorites: K6YZF-11 @ 145.030 Select Add to favorites Remove from favorites

In: 0/0 Out: 0/0 BPM: 0/0 Disconnected

*** Successfully connected to VARA FM TNC.
*** Ready

Enter the call sign of the Gateway you are trying to connect with.

Enter a frequency in the **Freq.:** field.

Note: For Signalinks the frequency itself is of no consequence, but it is best operating practice to enter the frequency you are working. It will matter once you use a transceiver with CAT.

Ensure that your transceiver is set to the correct frequency.

Click **Start**

VARA FM will connect and any traffic in your outbox addressed to the receiving station will be passed.

Using the VARA FM Channel Selector

In the session Window

Click on **Channel Selection**

Highlight a channel

Click **Select Channel** or **Double-click** the channel

Winlink will populate the channel information in the Winlink Session window for you.

Remember to set your transceiver to the frequency shown in the **Freq.:** field!

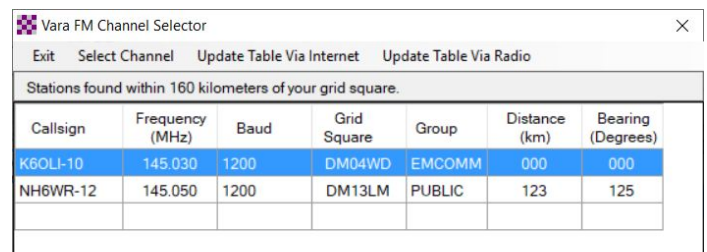



Vara FM Channel Selector

Exit Select Channel Update Table Via Internet Update Table Via Radio

Stations found within 160 kilometers of your grid square.

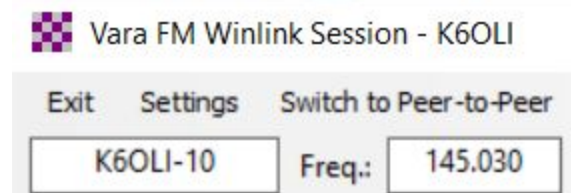
Callsign	Frequency (MHz)	Baud	Grid Square	Group	Distance (km)	Bearing (Degrees)
K6OLI-10	145.030	1200	DM04WD	EMCOMM	000	000
NH6WR-12	145.050	1200	DM13LM	PUBLIC	123	125



 Vara FM Winlink Session - K6OLI

Exit Settings Switch to Peer-to-Peer

K6OLI-10 Freq.: 145.030

Note: Update your channel table regularly, at least once a month. If you have access to the internet

Click **Update Table Via Internet**

Winlink Express

Quick Tip: Winlink Express Setup

If you have not setup Winlink Express, go to **Settings -> Winlink Express Setup** and fill in the appropriate fields.

You only have to do this once (unless your personal information or location changes, e.g. Call Sign, Registration Number, Locator, etc., then update in Winlink Express Setup).

Entering your locator here will help you later finding Winlink Gateways near you. You can look up your Maidenhead Locator at http://www.levinecentral.com/ham/grid_square.php

Peer-to-peer message

If you want to send a message as a Peer-to-Peer Message (P2P) you need to ensure that you select Peer-to-Peer Message in the Send as drop-down menu. Then click Post to Outbox.

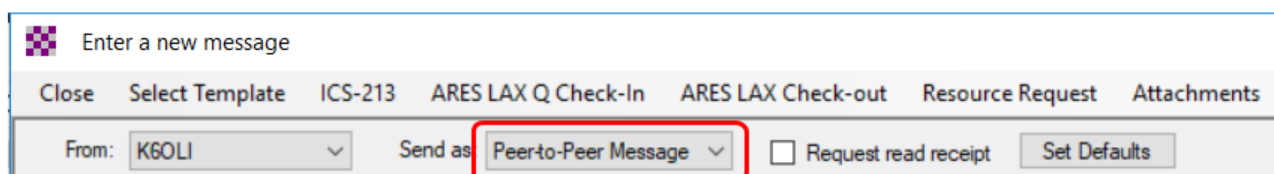

Enter a new message

Close Select Template ICS-213 ARES LAX Q Check-In ARES LAX Check-out Resource Request Attachments

From: K6OLI Send as: Peer-to-Peer Message Request read receipt Set Defaults

Double-check that the message is P2P by clicking on the **Outbox** and verifying under **Recipient** recipient's call sign is followed by **(P2P)**. In this example **KI6SC (P2P)** indicates the message is P2P.

No active session...

System Folders	Date/Time	Message ID	Size	Source	Sender	Recipient	Subject
Inbox (0 unread)	2018/11/21 01:42	W9W08D3TTP1Y	182	K6OLI	K6OLI	KI6SC (P2P)	Peer-to-Peer Message
Read Items (282)							
Outbox (1)							

- P2P Messages can only be sent to the call sign in the **To:** field and only when in a P2P session with that station.
- Both stations need to be in the same type of session at the same time for P2P traffic to be exchanged.

- You can push a message to the other station or they can pull the message from your Winlink by initiating the session on their end. Only the initiating station needs to enter the target station's call sign and then press start in a P2P session.
- You can enter multiple addresses in the To: field and Winlink will create separate, but identical messages for each recipient. Each recipient has to either pull the message from your system or you have to push each message to each respective recipient in separate sessions, i.e. enter each recipient's call sign in the Session window and pressing start. Having stations pull messages is more efficient for a central station.

Winlink Message (via Gateway, Telnet CMS, etc.)

If you want to send a message as a Winlink Message via a gateway or the internet you need to ensure that you select **Winlink Message** in the Send as drop-down menu. Then click **Post to Outbox**.

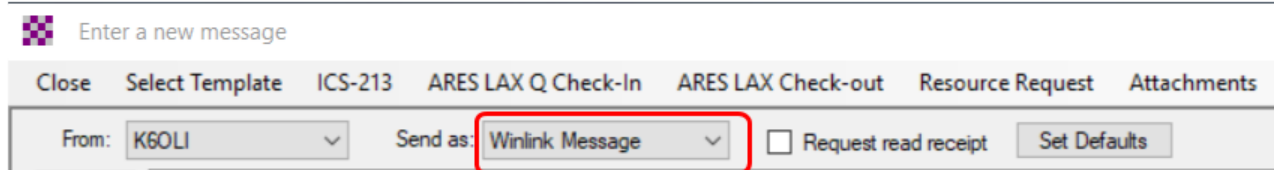

Double-check that the message is a Winlink Message by clicking on the Outbox. Winlink Messages are preceded by **//WL2K** in the **Subject** have no (P2P) after the call sign under Recipient.

System Folders		Date/Time	Message ID	Size	Source	Sender	Recipient	Subject
Inbox (0 unread)		2018/11/2...	CUG4N9V...	196	K6OLI	K6OLI	HB9AUR	//WL2K Winlink Message Example
Read Items (282)		2018/11/21 01:42	W9W0BD3TTP1Y	182	K6OLI	K6OLI	KI6SC (P2P)	Peer-to-Peer Message
Outbox (2)								

- In the example above, we could first initiate a regular Winlink Session with a Gateway (or through the Internet via Telnet) and the message to HB9AUR would be sent. The message to KI6SC (P2P) would stay in the Outbox.
- We could also first initiate P2P Session with KI6SC and the message to KI6SC (P2P) would be sent. The message to HB9AUR would stay in the Outbox in this example.
- You can change whether a message is sent via Winlink Gateway or P2P after the fact by double-clicking on the message in the **Outbox**, changing the mode (**Winlink Message, Radio Only, Peer-to-Peer**) in the **Send as** dropdown menu and then clicking **Post to Outbox**.

Appendix I

Soundcard Options

Signalinks mentioned above are widely available, easy to use and compatible with many radios and many digital software packages. Like XGCOMMS boards Signalinks at present support NARROW mode only due to hardware restrictions. NARROW will support the most number of radios. NARROW supports eight to ten times the speed of Packet.

If you want to use WIDE, have a rig that supports direct access to the discriminator (i.e. 9600), or you would like to set up a VARA FM gateway you may want to consider an RA-Board or similar or sing a rig with a quality built-in soundcard. These options offer circuits that will handle PTT instead of using VOX. WIDE supports twice the speed of NARROW.

RA Board

Click **Settings**

Select **PTT**

Select radio button **RA Board**

Click **Close**

Click **Settings**

Select **SoundCard**

Device Input **USB PnP Sound Device**

Device Output **USB PnP Sound Device**

Auto Tune with another station

Click **Close**

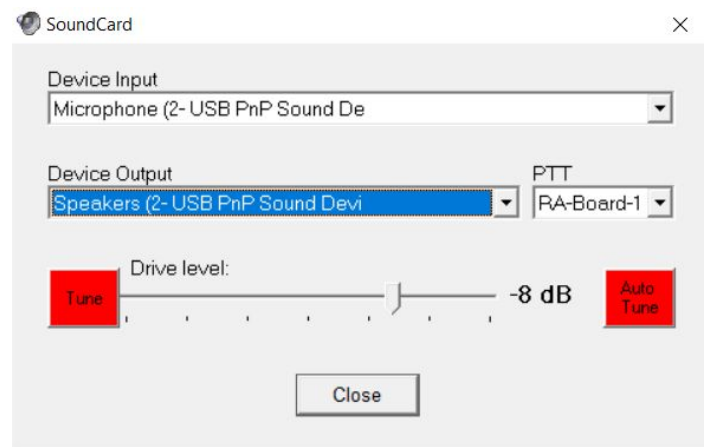

Built-in soundcard

Example: **ICOM 7100**

The ICOM 7100 and similar rigs have excellent built-in soundcards for digital operation.

Make sure you install the USB drivers for the IC-7100 and similar before connecting the radio to your computer.

